

Vera 508-5  
CCK-HE150

REVISIONS				
ZONE	REV.	DESCRIPTION	DATE	APPROVED
	00	AÇIKLAMA	01.01.2011	ONAYLAYAN
	01	Kollektör pul çıkarma yapıldı	8.03.2021	S.KOMAN

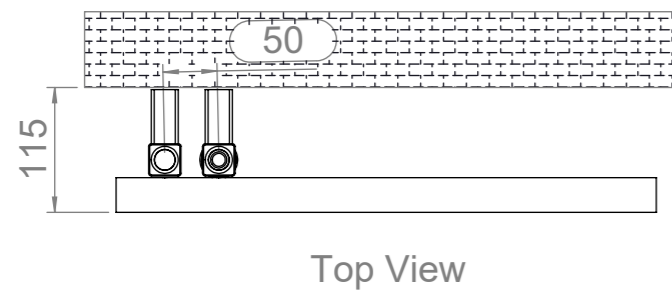

**Installation Accesories:**

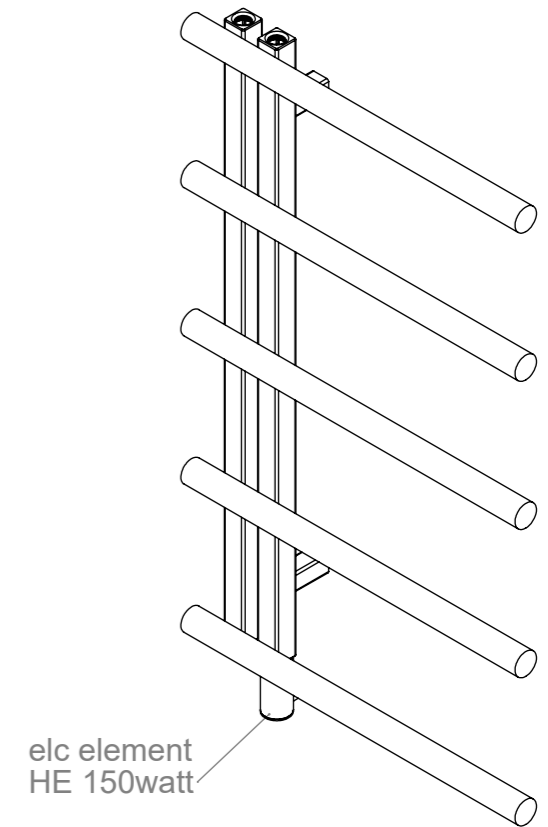
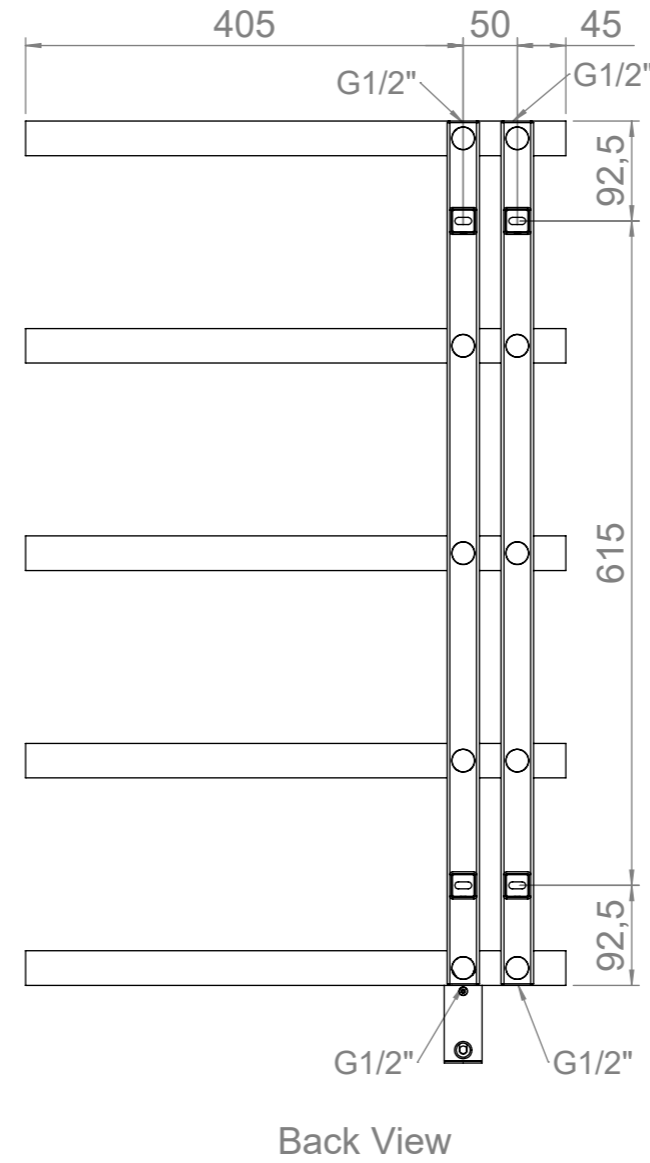
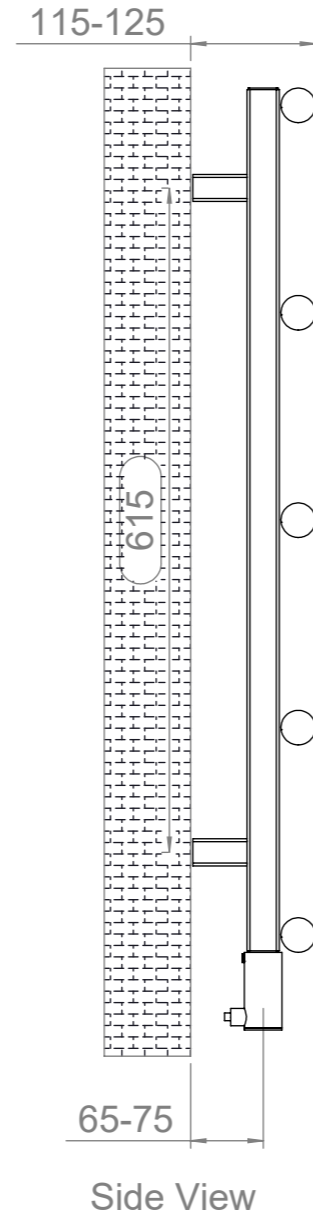
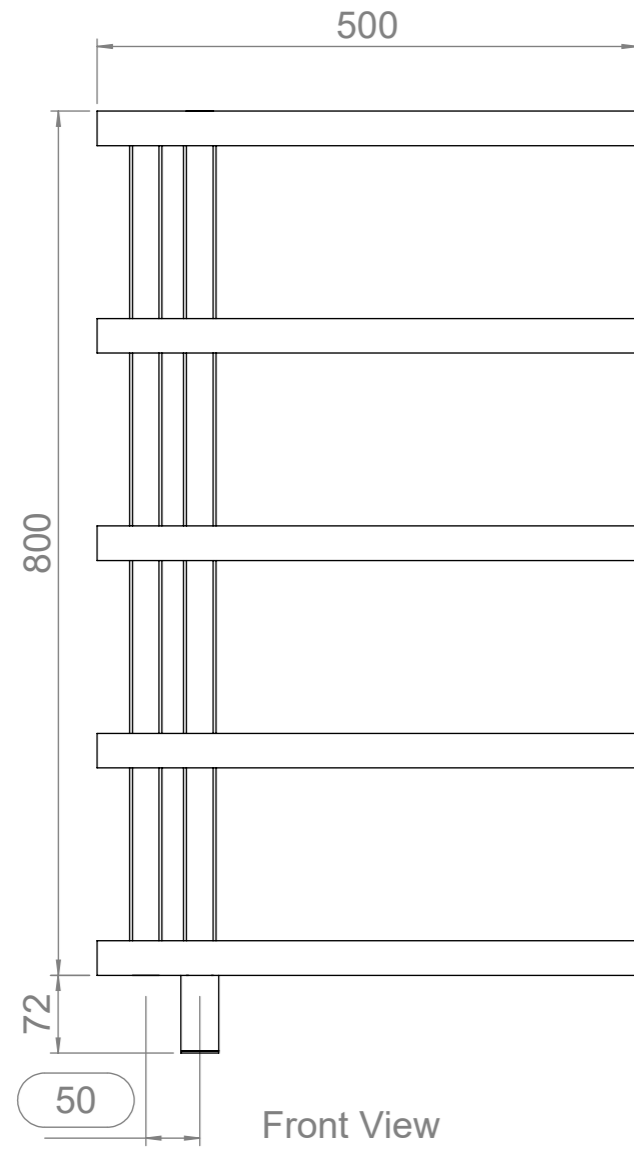
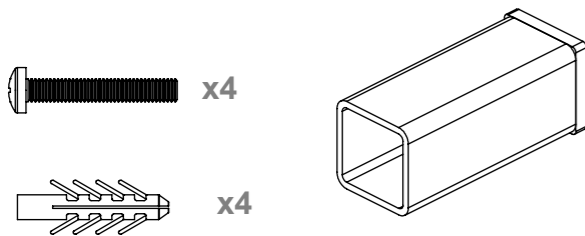

**Fitting Position:**

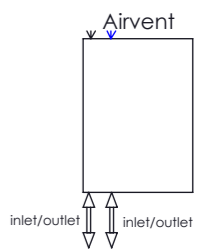

Vertical Mount  
All Dimension are in mm  
Max.Working Pressure = 10 Bar  
Max.Working Temperature=95° C  
Inlet / Outlet : 1/2" BSP  
Fuel: H